



Delta InfraSuite Cast Resin Busway System

BR Series, CE Certified, 250A-2000A



Delta Cast Resin Busway System

A Flexible, Safe, and Reliable Low Voltage Power Distribution Solution

With the brand vision “Smarter, Greener, Together,” Delta has utilized its industry-leading power electronics technology to develop the Busway BR Series for data center applications. Different from a conventional power cable system or sandwich busway solutions, Delta has adopted epoxy cast resin technology to significantly increase IP protection level, safety, and reliability. Delta's solution is ideal for use in a variety of industries and climate conditions. The superior electrical and mechanical characteristics of resin minimize the Busway BR Series' dimensions and simplify its structure. The Busway BR Series also has an extended product life cycle, increased reusability, and achieves significant energy savings for customers.

Customer Value

The Busway BR Series features:

- Successive plug-in slots are available for expansion and power distribution. Data centers can use them freely
- Ultra safe solution that satisfies the requirements of data centers
- Conforms to different standards, depending on market or customer needs, such as IEC, CNS and GB
- Space-saving and weight-saving solution that overcomes space and loading problems of the data center.
- Highly integrated composite materials that significantly reduce EMC and protect precision devices in the data center, and are safe for human health.

Contents

• Product Introduction	2
• Data Center Application	3
• Customer Benefits	4
• Product Advantages	5 - 6
• Colors	7
• Technical Specifications	8 - 10
• Plug-in Unit	11 - 15
• End Feed Box	16
• Busway Configuration	17
• Monitoring Module	18
• Delta Data Center Solutions	19 - 20
• Delta Group Introduction	21 - 22

Delta's Busways vs. Traditional Cable

Delta's Busways excel over traditional cables in terms of safety, electrical properties, reliability, and scalability, making them the best choice for companies looking at optimum Total Cost of Ownership (TCO).

	Cast Resin Busway System	Typical Power Distribution by Cables
System flexibility	Easily detaching joints, replaceable, re-usable and highly adaptable to system design changes	Needs re-wiring in case of system changes
Installation and configuration	Quick installation and configuration	Wiring over premises, costly and time-consuming
Space use efficiency	Only 30% of traditional cable wiring, effective in saving installation space	Power distribution by cable needs PDU or RPP that occupies white space
Appearance	Easy to identify and manage at a glance	Messy power wiring, complicated looks
Fire resistance	High, IEC60331/BS6387	None
IP Rating	The protection level is primarily IP20 for data center applications. It can reach up to IP55 per requirement	Not specified in the general technical data
Resistance to chemicals and corrosion	Excellent	Poor
Instantaneous short-circuit strength	High	Low
Overload capacity (+25% 2hrs)	High	Low in heat resistance (up to about 60°C), thus it can be dangerous when overloaded, leading to accelerated insulating materials aging and reduced service life
Insulation rating	High, resin insulation Class F (155°C).	Low

Busway for Data Center Applications

With the recent wave of Big Data and IoT, data centers are now responsible for more computing, communication and storage functions. In addition to a wider scope, the power density of a single rack cabinet has gradually increased. Effective space utilization is a great challenge for data center construction.

The Delta Cast Resin Busway System BR Series is exclusive for data center applications. Thanks to epoxy insulation technology, it has a compact structure and size, as well as low EMC that allows it to overcome space limitations in server rooms. Data center designers can easily do wiring construction close to data cables without the fear of an impact on their health due to low electromagnetic radiation.

In addition, the plug-in unit can be customized per customers' requirements. It is flexible for use with different power supply systems of server racks. The plug-in unit also applies to the flexible successive plug-in slots and is hot swappable. Therefore, it is not constrained by data center space. Customers can carry out expansion or distribution anywhere, which is very flexible.

Busway Systems in a Data Center

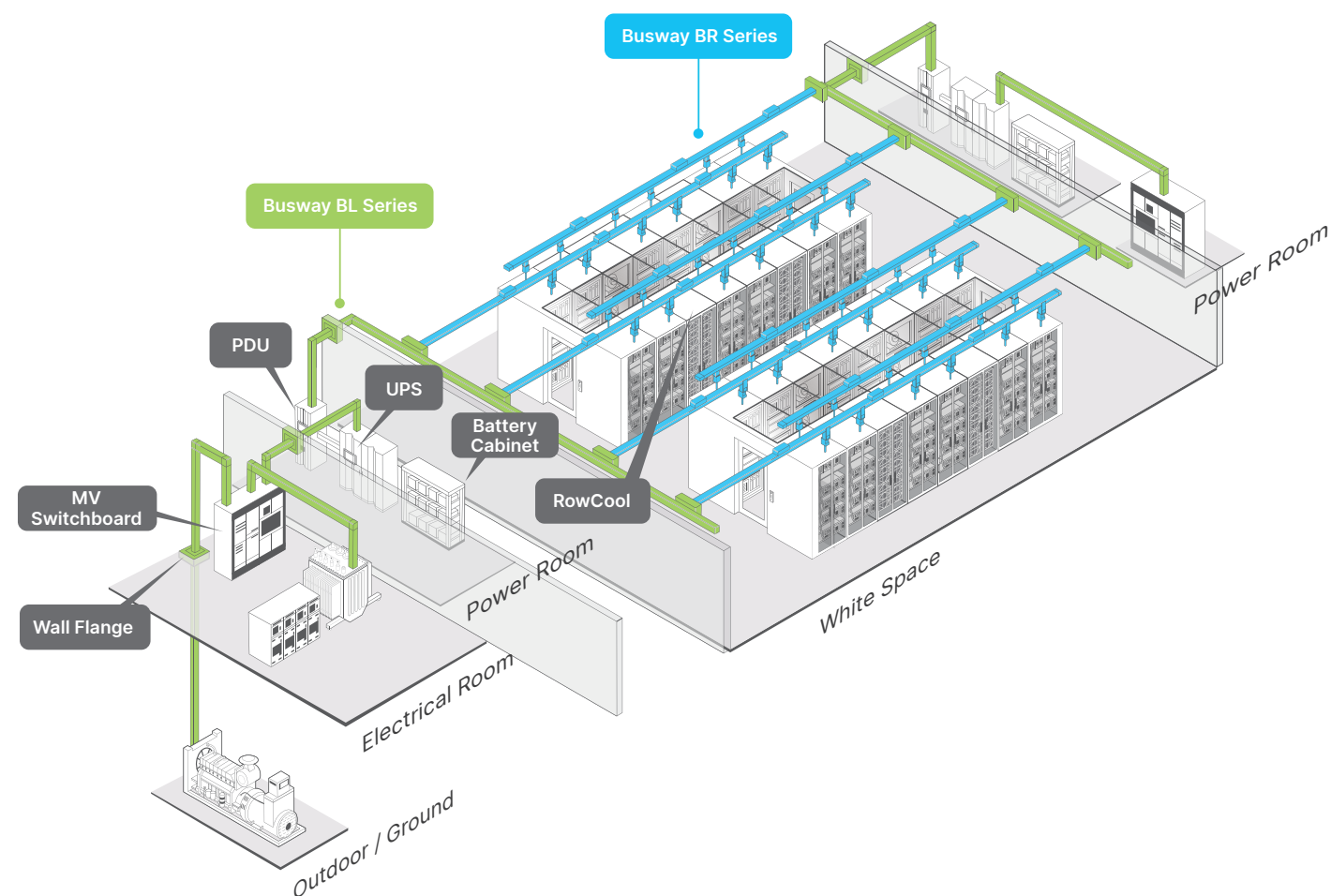

Customer Benefits

Safe, Reliable, Flexible and Efficient



Safe

The IP55 protection level provides water resistance and is dustproof. The busway remains highly reliable even in harsh environmental conditions, such as high humidity and dripping water. Delta has considered all aspects of the structure design.

- Installation: Attentive foolproof designs are available for every installation step
- Operation: Tool-less design for users to easily install plug-in units
- Compliant with IEC 61439/UL 857

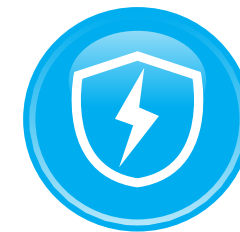

Reliable

The busway structure is an aluminum housing. The busway adopts epoxy cast technology, which is filled and molded into one piece. Its advantages include:

- Minimizes risk from the stronger structure during lifting and assembly on data center sites
- Shield technology ensures optimum sequencing of the conductor. The integrated composite materials reduce EMC significantly and mitigate the interference to precision devices
- No maintenance is required



Efficient

The product design and installation uses many plug-ins and modular design concepts and is easy-to-use during the installation, operation and expansion phases. Benefits of the successive plug-in slots and modular design are:

- Unconstrained by space or location, the busway can be designed effectively and installed without professional technicians
- The plug-in unit adopts a modular design that can be expanded simply and quickly
- Customers can save time on waiting for materials if there is any change in design
- Users can save time and costs on installation, expansion, and alteration

Product Advantages

Busway Body

- Wide power ratings ranging from 250A to 2000A
- Up to 200% neutral
- Highly integrated cast resin technology with epoxy inside
- Pole locations can be reserved or customer can choose the successive plug-in slots upon request
- Numerous standard lengths are available, such as 1M, 2M, 3M, 4M
- Length can be customized upon customer request
- IP protection level up to IP55

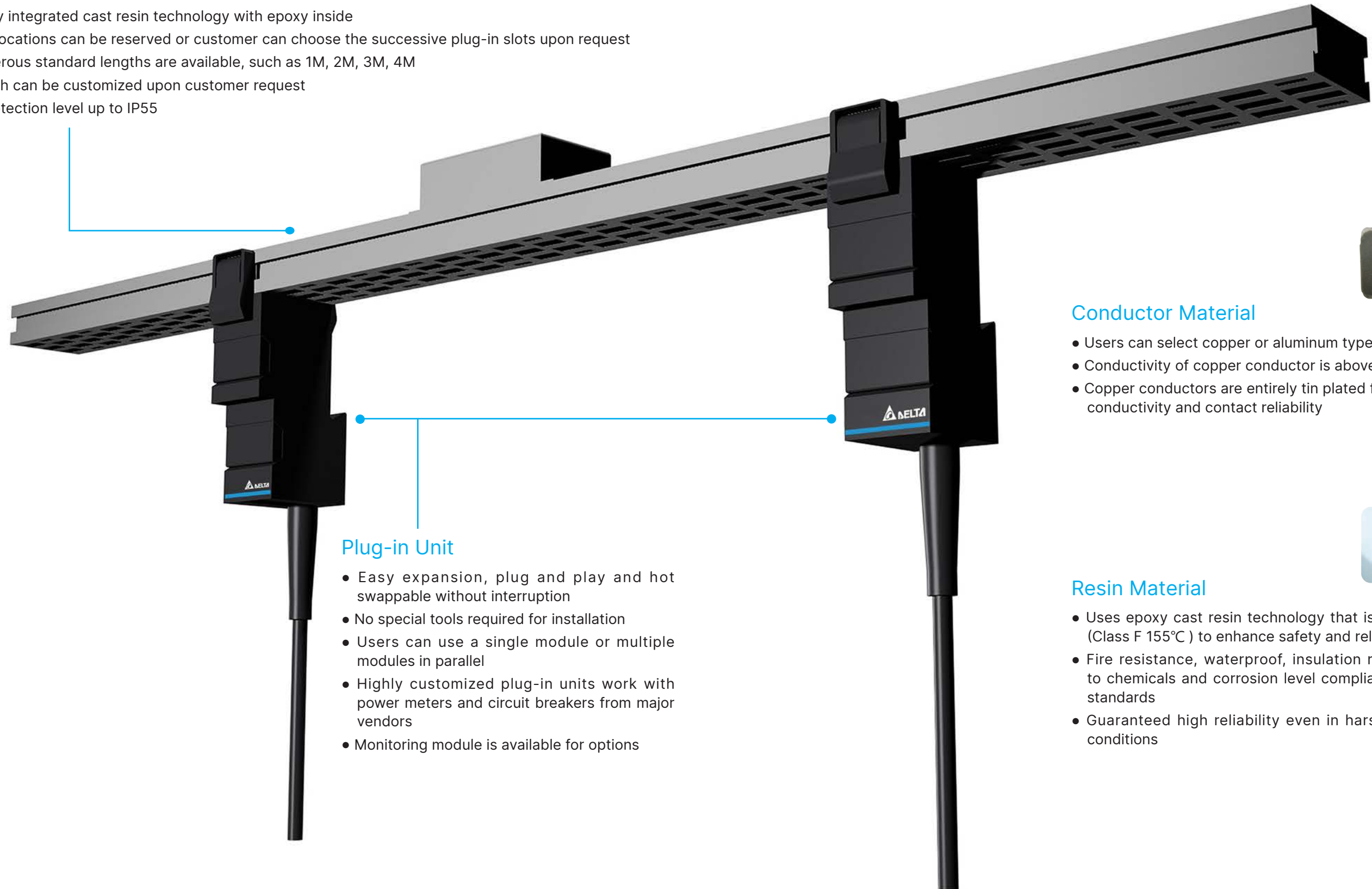

Plug-in Unit

- Easy expansion, plug and play and hot swappable without interruption
- No special tools required for installation
- Users can use a single module or multiple modules in parallel
- Highly customized plug-in units work with power meters and circuit breakers from major vendors
- Monitoring module is available for options

Conductor Material

- Users can select copper or aluminum types as needed
- Conductivity of copper conductor is above 99.9%
- Copper conductors are entirely tin plated for optimum conductivity and contact reliability

Resin Material

- Uses epoxy cast resin technology that is highly insulating (Class F 155°C) to enhance safety and reliability
- Fire resistance, waterproof, insulation rating, resistance to chemicals and corrosion level compliant with industrial standards
- Guaranteed high reliability even in harsh environmental conditions

Colors

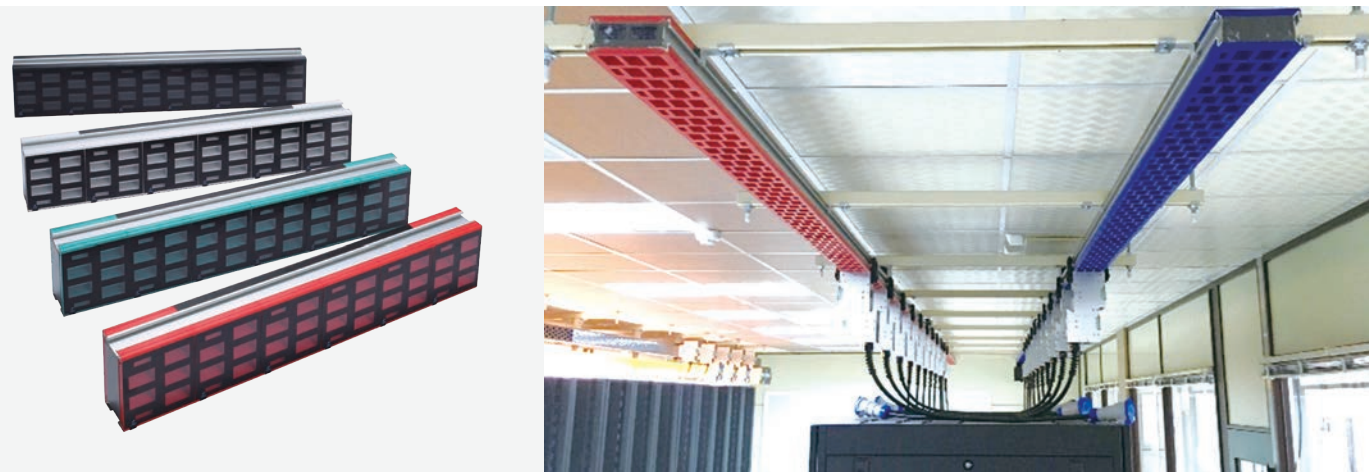

Standard



	Dark Blue	Black	Warm Red
Pantone Color	Pantone 2146 C	Pantone Black C	Pantone 7621 C

Optional



	Light Blue	Yellow	Orange	Blue Green
Pantone Color	Pantone 18-4538 TPG	Pantone Yellow C	Pantone 7577 C	Pantone 7717 C



	Bright White	Grayish White	Gray
Pantone Color	Pantone 11-0601 TCX	Pantone 13-4104 TPG	Pantone 7538 C

Technical Specifications

Busway Rating		250A	400A	600A	800A	1000A	1250A	1600A	2000A
Models	Copper	BRC02	BRC04	BRC06	BRC08	BRC10	BRC12	BRC16	BRC20
	Aluminum	BRA02	BRA04	BRA06	BRA08	BRA10	BRA12	BRA16	BRA20
Rated Current		250A	400A	600A	800A	1000A	1250A	1600A	2000A
Rated Voltage		1000V							
Frequency		50/60Hz							
Conductor		Copper purity: 99.9% Conductivity: 99.9% IACS Aluminum purity: 98.8% Conductivity: 56.0% IACS							
Conductor Plating		Tin plating (Std)							
Insulation Material		Epoxy cast resin							
Insulation Class		Class F (155°C)							
Enclosure/ Housing		Epoxy/Aluminum							
Fire Protection		UL94 V0							
Ingress Protection Rating		IP20 ; IP55 (optional)							
Mechanical Impact		IK10							
Earthquake Test		0.8g [magnitude >7] ; Zone 4							

PLUG-IN UNIT

Contact Design	Plug-in type
Types	Rv: mounted to busway section vertically Rh: mounted to busway section horizontally
Configurations	Plug-in unit with MCB/ELCB/RCBO Plug-in unit with MCB/RCB + Socket-outlets Plug-in unit with MCB/RCBO + Power Meter Plug-in unit with MCB + Over Temperature Detect System
Max. Rating	400A
MCCB Brands	ABB(Std.), Mitsubishi, Fuji, GE, Schneider or Customer specified
Ingress Protection Rating	IP20
Panel Coating	Powder coated paint
Color	RAL 9011/RAL9003

GENERAL DATA

Standards	IEC61439, IEC60529, IEC60331, IEC60332 CNS14286, CNS12514, CNS14165, CNS11073 UL857
Ambient Temperature	-20°C/+50°C avg. 35°C
Altitude	Below 2000m from sea level

Technical Specifications



Copper

Busway Rating	250A	400A	600A	800A	1000A	1250A	1600A	2000A
Models	BRC02	BRC04	BRC06	BRC08	BRC10	BRC12	BRC16	BRC20
Rated Current	250A	400A	600A	800A	1000A	1250A	1600A	2000A

IMPEDANCE VALUES ARE FOR BUSWAY OPERATING AT 20/80°C TEMPERATURE

Resistance R_{20}	$\mu\Omega/m$	213.0	178.0	117.8	74.6	55.8	37.2	24.6	18.8
Resistance R_{80}	$\mu\Omega/m$	263.2	220.0	145.6	92.2	69.0	46.0	30.4	23.2
Reactance X_{50}	$\mu\Omega/m$	138.1	129.5	87.8	67.8	49.8	38.5	25.5	20.1
Impedance Z_{50}	$\mu\Omega/m$	297.2	255.3	170.0	114.4	85.1	60.0	39.7	30.7
Reactance X_{60}	$\mu\Omega/m$	165.7	155.4	105.3	81.3	59.8	46.2	30.6	24.1
Impedance Z_{60}	$\mu\Omega/m$	311.0	269.3	179.7	122.9	91.3	65.2	43.1	33.5

CONDUCTOR CROSS-SECTION AREA

L1,L2,L3	mm ²	50.0	72.5	145	232	307.4	464	696	928
N (100%)	mm ²	50.0	72.5	145	232	307.4	464	696	928
G (Internal)	mm ²	50.0	72.5	72.5	116	153.7	232	348	464

BUSWAY DIMENSIONS

W x H	mm	117×58	117×58	117×58	117×73	117×86	117×113	117×153	117×193
Weight	Kg/m	12	13	15	23	32	46	59	65
Joint		1-Plug-in	1-Plug-in	2-Plug-in	Bolt-on	Bolt-on	Bolt-on	Bolt-on	Bolt-on

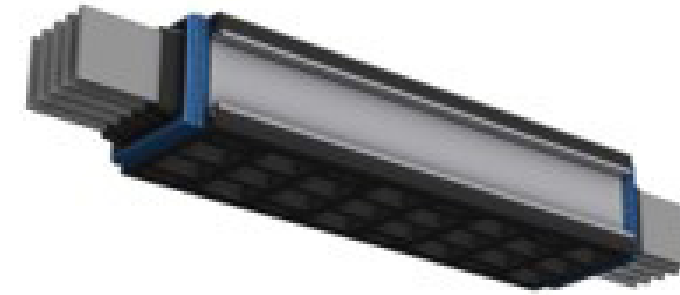
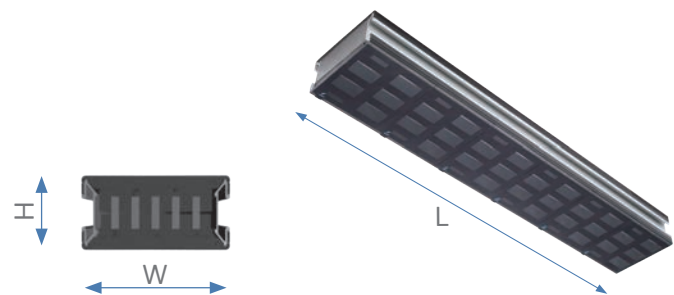

Aluminum

Busway Rating	250A	400A	600A	800A	1000A	1250A	1600A	2000A
Models	BRA02	BRA04	BRA06	BRA08	BRA10	BRA12	BRA16	BRA20
Rated Current	250A	400A	600A	800A	1000A	1250A	1600A	2000A

IMPEDANCE VALUES ARE FOR BUSWAY OPERATING AT 20/80°C TEMPERATURE

Resistance R_{20}	$\mu\Omega/m$	312.0	213.0	122.0	93.5	62.6	49.7	41.8	25.4
Resistance R_{80}	$\mu\Omega/m$	385.6	263.2	150.8	115.5	77.4	61.4	51.7	31.4
Reactance X_{50}	$\mu\Omega/m$	150.0	138.1	100.0	59.8	46.7	40.8	32.7	19.0
Impedance Z_{50}	$\mu\Omega/m$	413.7	297.2	180.9	130.1	90.3	73.8	61.1	36.7
Reactance X_{60}	$\mu\Omega/m$	180.0	165.7	120.0	71.7	56.0	49.0	39.2	22.8
Impedance Z_{60}	$\mu\Omega/m$	425.5	311.0	192.7	136.0	95.5	78.6	64.8	38.8

CONDUCTOR CROSS-SECTION AREA

L1,L2,L3	mm ²	100	145	232	307.4	464	580	928	1160
N (100%)	mm ²	100	145	232	307.4	464	580	928	1160
G (Internal)	mm ²	50	72.5	116	153.7	232	290	464	580

BUSWAY DIMENSIONS

W x H	mm	117×58	117×58	117×73	117×86	117×113	117×133	117×193	117×233
Weight	Kg/m	11	12	14	21	30	42	55	59
Joint		1-Plug-in	1-Plug-in	2-Plug-in	Bolt-on	Bolt-on	Bolt-on	Bolt-on	Bolt-on

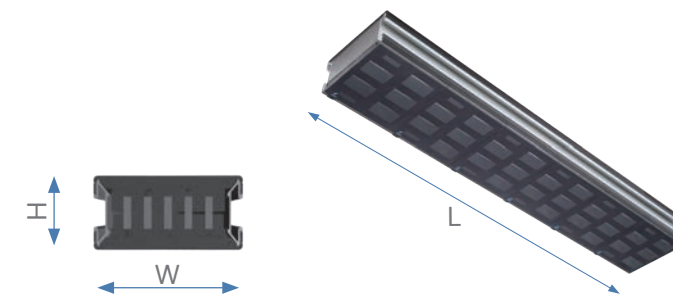

Plug-in Unit (Rv Type)

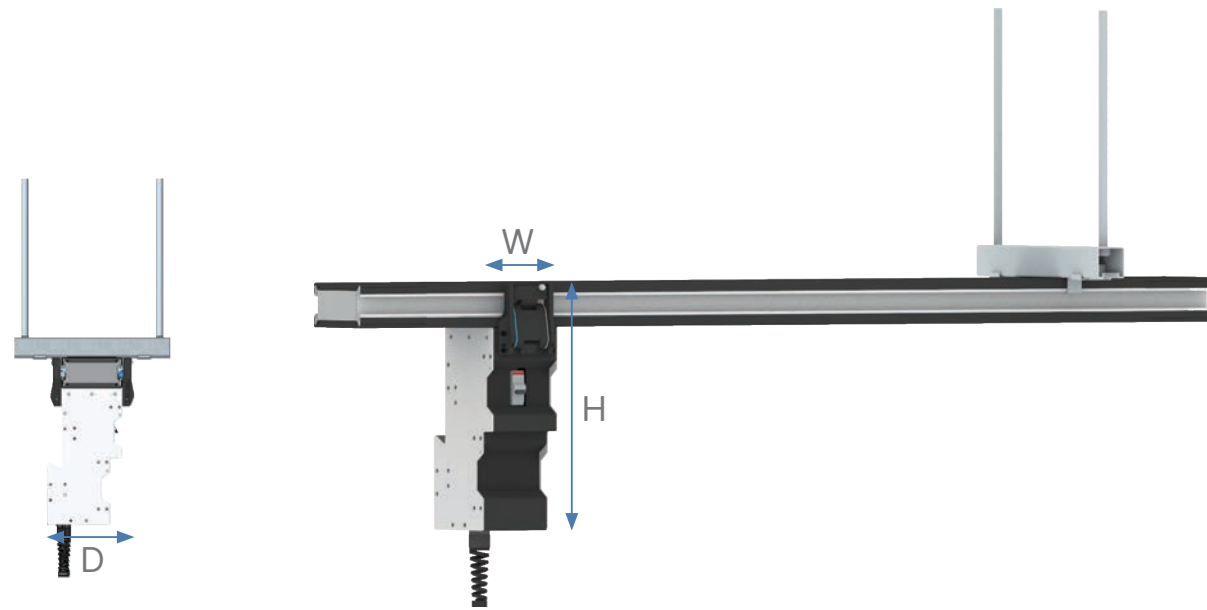

Rv Type

Ratings	16A	32A	63A	125A	250A	400A
Height	330mm					
Depth	165mm					
Width	100mm		200mm		300mm	
IP Rating	IP20					
Weight	3kg		5kg	12kg	20kg	26kg

Standard Configurations for Plug-In Unit (Rv Type)

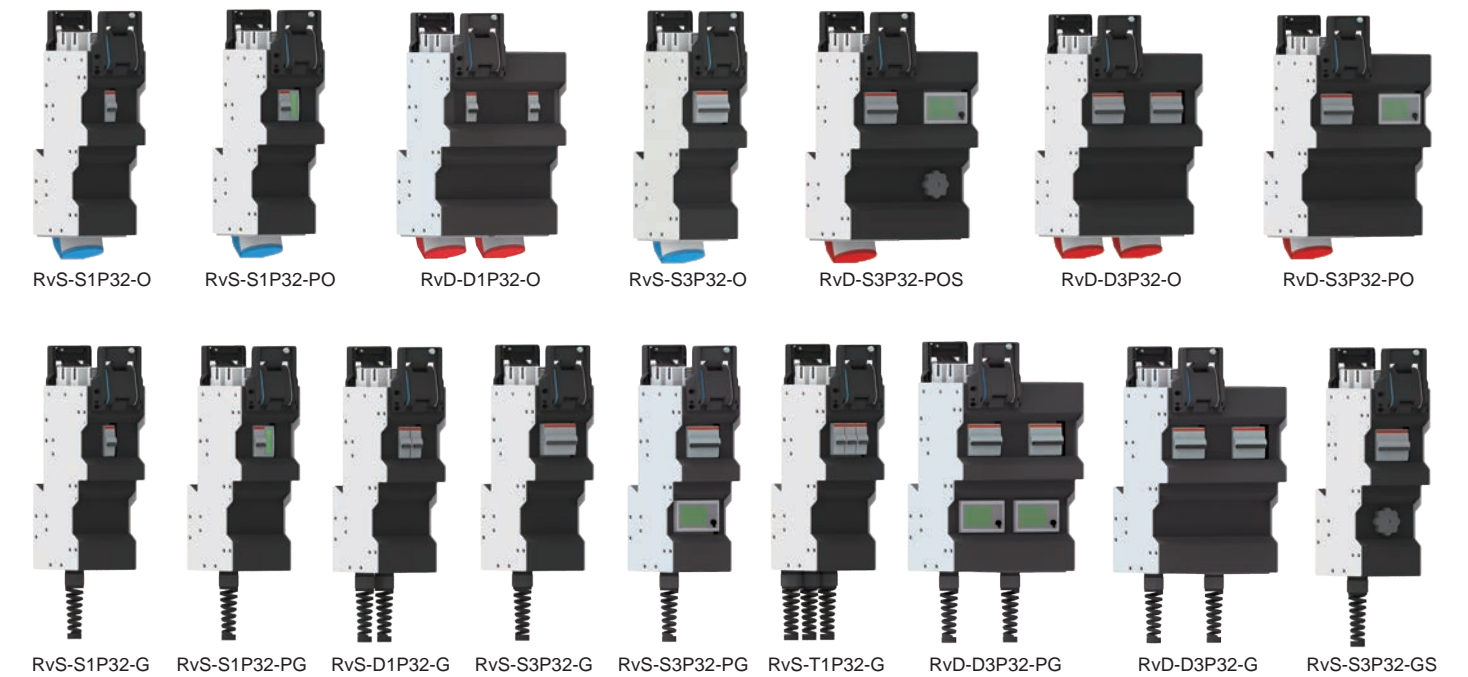
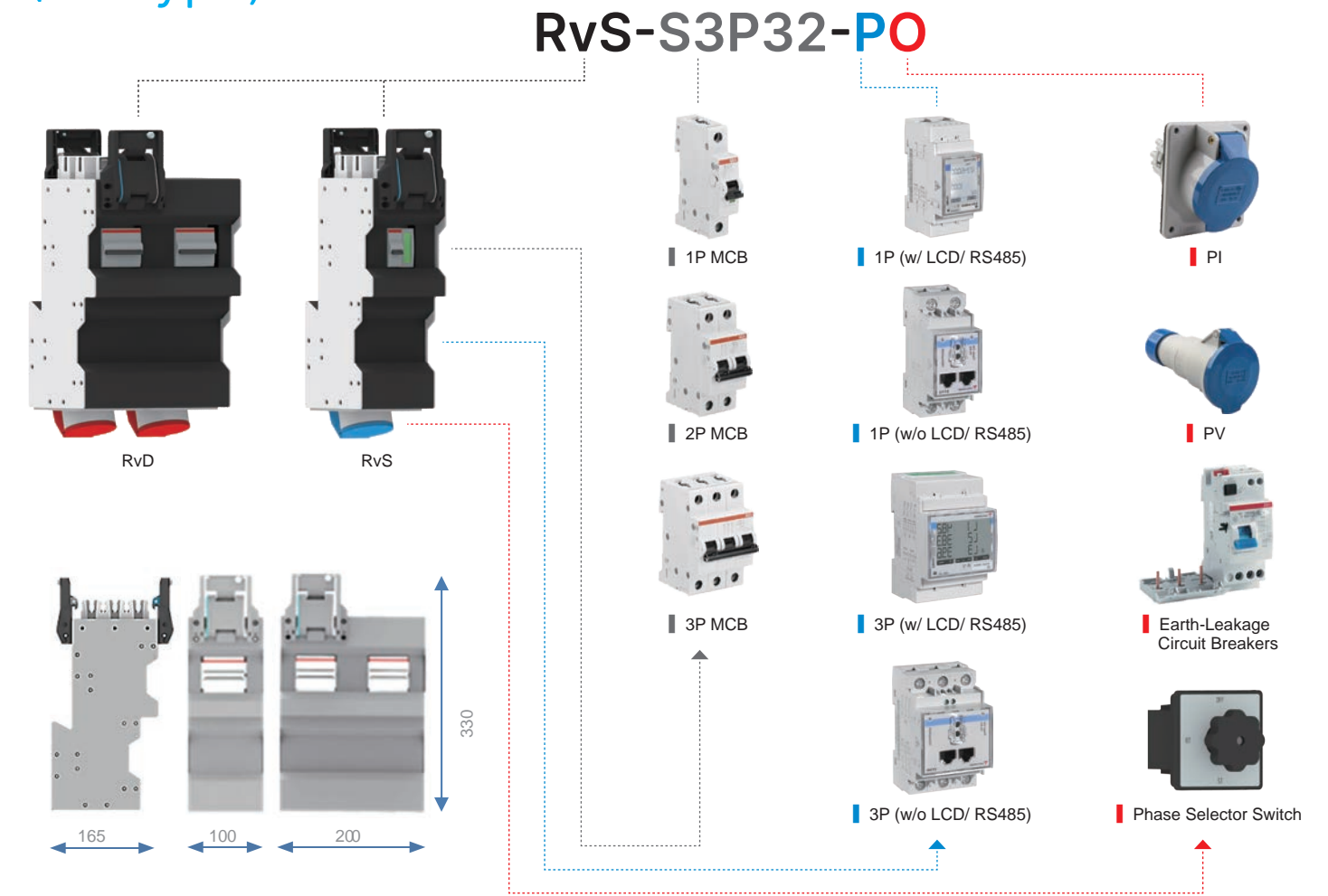

Plug-in Unit (Rh Type)

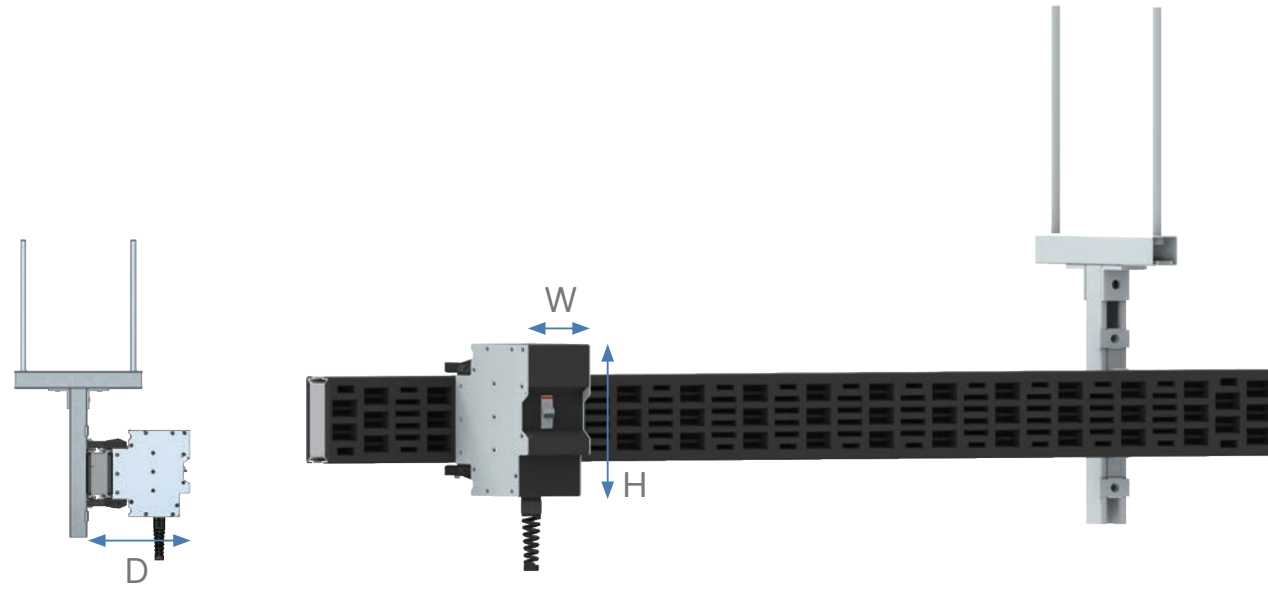

Rh Type

Ratings	16A	32A	63A	125A	250A	400A
Height	250mm					
Depth	243mm					
Width	100mm			200mm	300mm	
IP Rating	IP20					
Weight	3kg		5kg	12kg	20kg	26kg

Standard Configurations for Plug-In Unit (Rh Type)

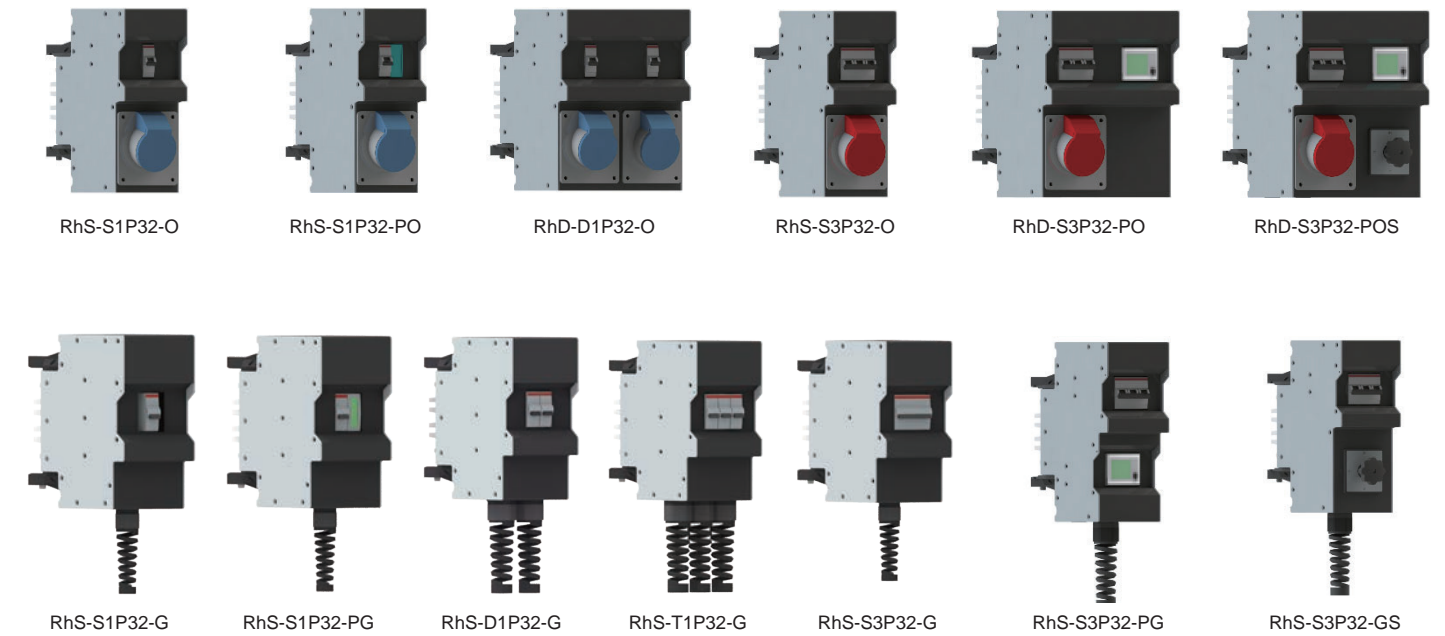
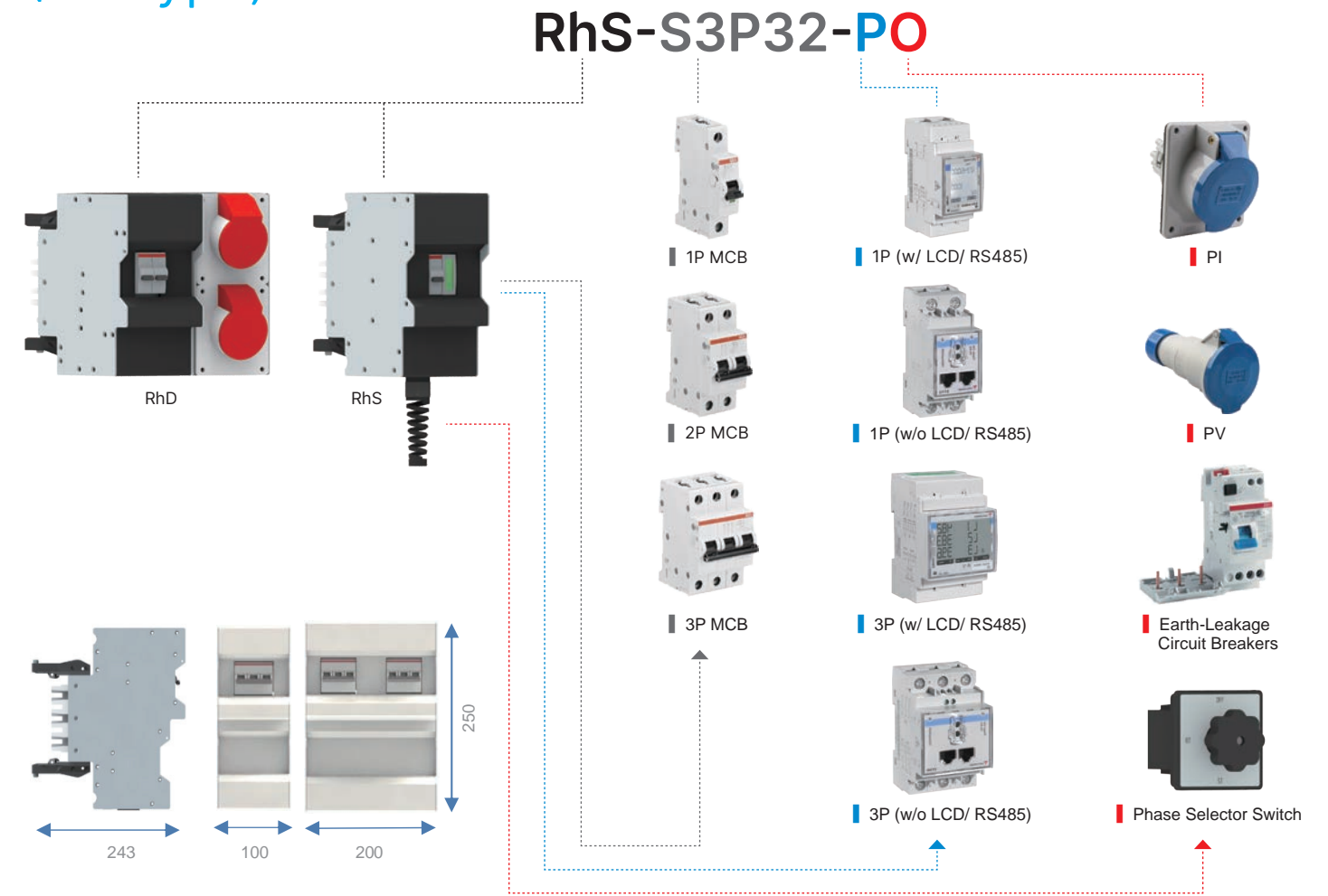

Plug-in Unit Part Number Coding Principle

RvS-S3P32-PO.02

PRODUCT CODE
 Rv: VERTICAL BOX
 Rh: HORIZONTAL BOX
 ED: END FEED BOX

BOX CODE
 S: SINGLE BOX
 D: DOUBLE BOX
 T: TRIPLE BOX

OUTPUT LOOP CODE
 S: SINGLE LOOP
 D: DOUBLE LOOP
 T: TRIPLE LOOP

POLE NO.
 1P
 2P
 3P (L1,L2,L3)
 4P (L1,L2,L3,N)

AMPERAGE RATING
 16
 32
 63

COMPONENT
 P: POWER METER
 O: SOCKET-OUTLETS
 G: CABLE/ PLUGS
 E: EARTH-LEAKAGE CIRCUIT BREAKERS
 S: CAM SWITCH

SERIAL NO.

End Feed Box / End Cable Box

ECM-2506NF250CW-P

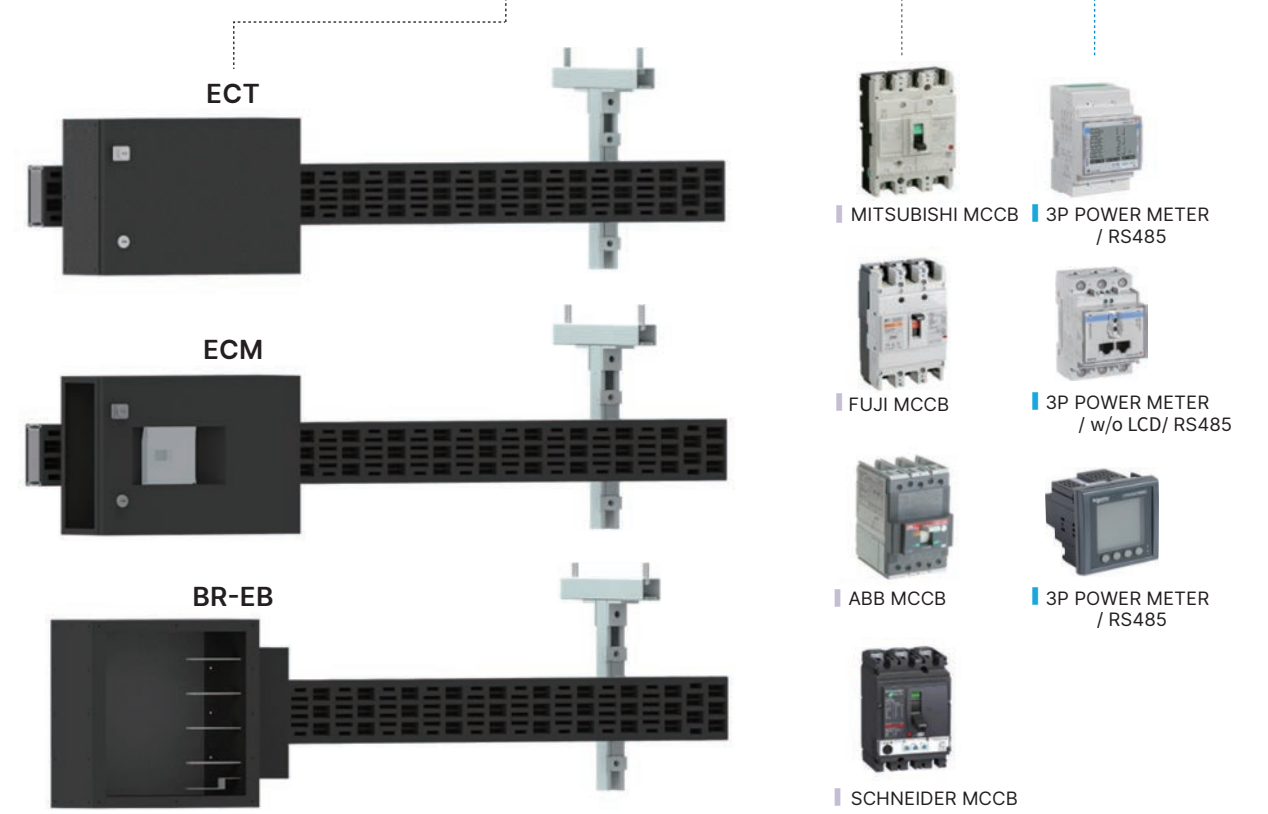

Ratings	250A		400A		630A		800A	1000A	1250A	1600A	2000A
Model (Type)	ECM-250 MCCB	ECT-250 Terminal	ECM-400 MCCB	ECT-400 Terminal	ECM-630 MCCB	ECT-630 Terminal	BRC086EB Terminal	BRC106EB Terminal	BRC126EB Terminal	BRC166EB Terminal	BRC206EB Terminal
W	480mm	430mm	480mm	430mm	480mm	430mm	500mm				
H	300mm						650mm				
D	240mm	160mm	240mm	160mm	240mm	160mm	220mm	233mm	260mm	300mm	340mm
IP Rating	IP42										
Weight	17kg	15kg	19kg	15kg	20kg	17kg	35kg	38kg	45kg	55kg	65kg

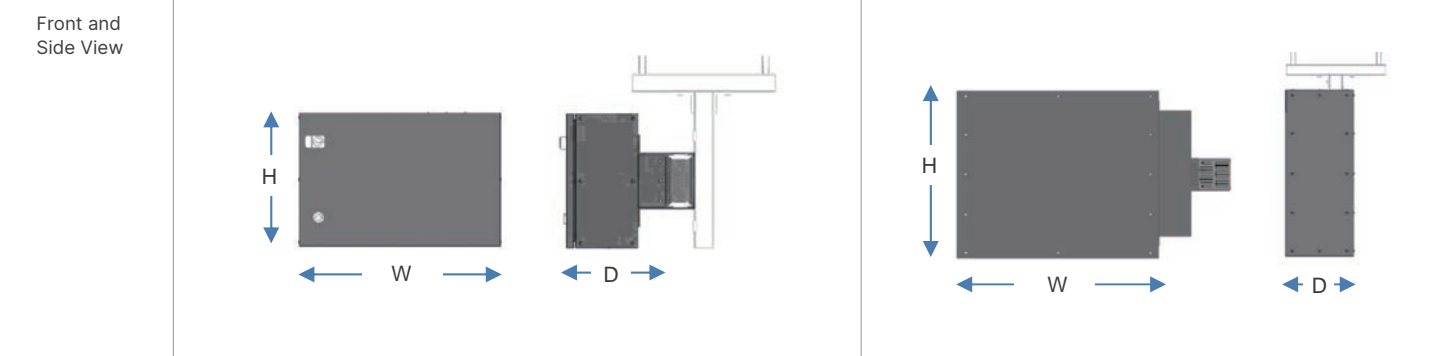

Busway Configuration

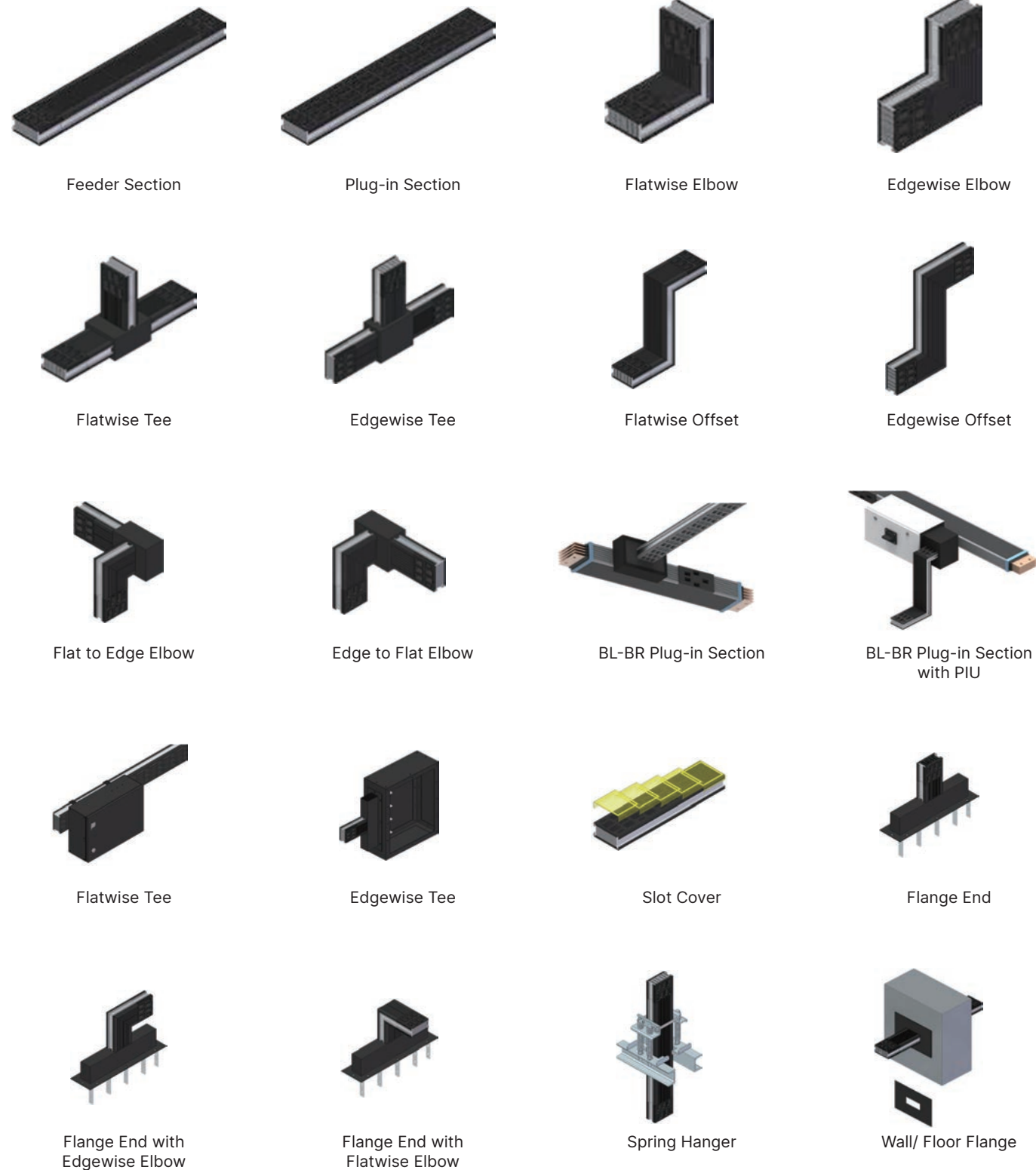

Monitoring Module

The plug-in unit can fit within the monitoring module. The power information can be displayed or transmitted to the monitoring system via RS485.

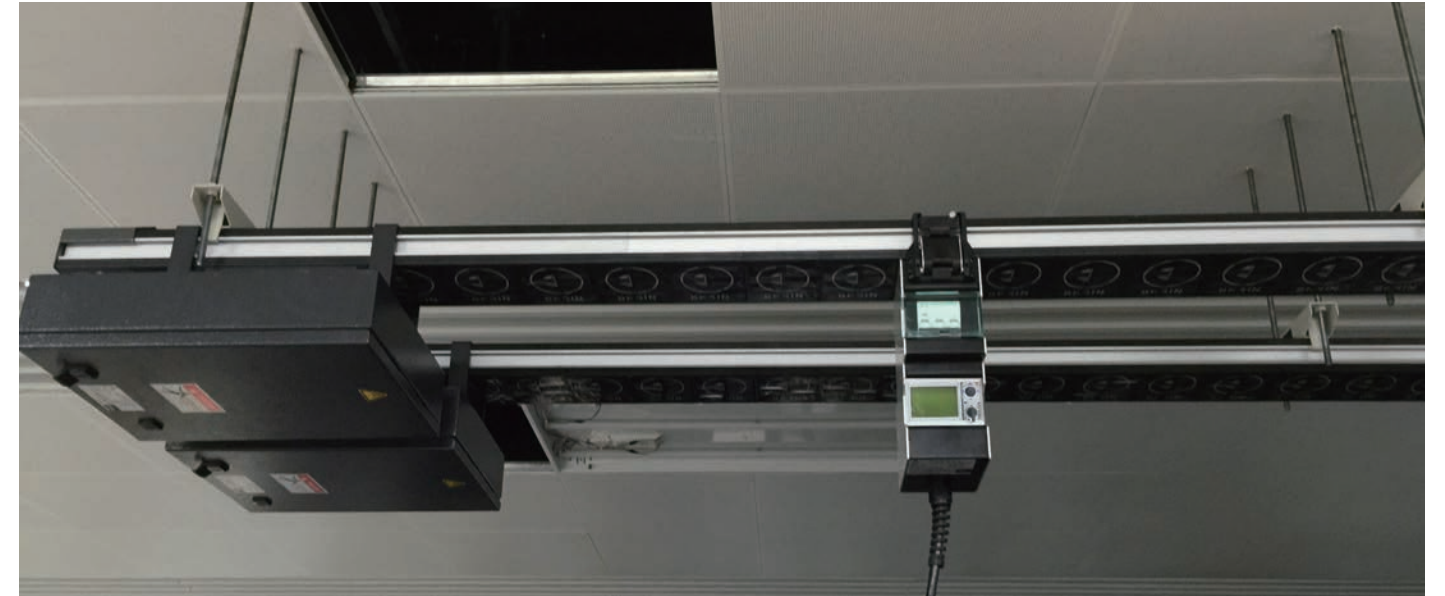

Data Center Infrastructure Management (DCIM)

The most advanced datacenter monitoring solutions seamlessly unite individual systems within a unified central platform. The Delta Data Center Infrastructure Management (DCIM) system merges all tasks related to datacenter facilities and IT equipment management onto a single platform. Effectively oversee energy, power systems, cooling, environment, security, asset management, server monitoring, and more across multiple sites. The system incorporates advanced alert algorithms across the infrastructure, aiding in resource optimization and reducing the risk of downtime.

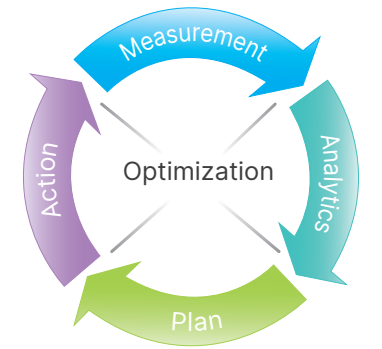

Product Modules

<p>Operation Power Cooling Environment Security IT Device</p>	<p>PUE Energy PUE/ EUI Electricity Cost Energy Analysis</p>	<p>Capacity Capacity Analysis Best Installation Position Capacity Plan</p>	<p>Smart Energy Energy Optimization Precision Control Abnormality Prediction</p>	<p>BIM 3D 3D Navigation Device Summary Event Highlight</p>
<p>Incident Assign Owner Search History Classification Business Impact Business Risk</p>	<p>Asset Asset Model Document Quick Search Connectivity Failure Impact</p>	<p>Work Order Template Schedule/ Event Trigger Statistics and History</p>	<p>Asset Inspection On-site Audit App Download Plan Executing History Data Analysis</p>	<p>Analytics Predict Trend Capacity Forecast Modeling</p>

Delta: Your Trusted Data Center Solutions Provider

Our commitment to innovative design and industry-leading technology ensures that we deliver highly reliable and efficient power management products and data center infrastructure solutions. With Delta, you can count on uninterrupted power flow and optimized performance, all while minimizing your Total Cost of Ownership.

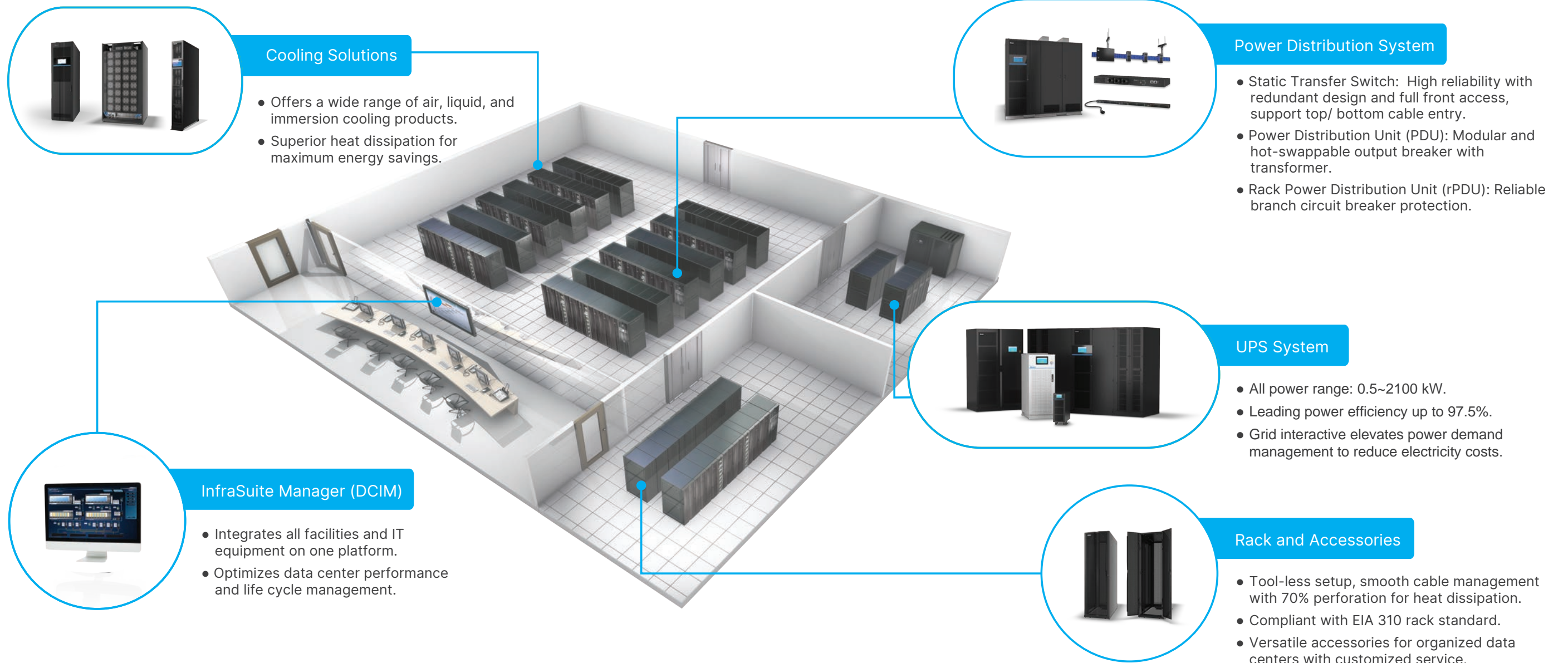
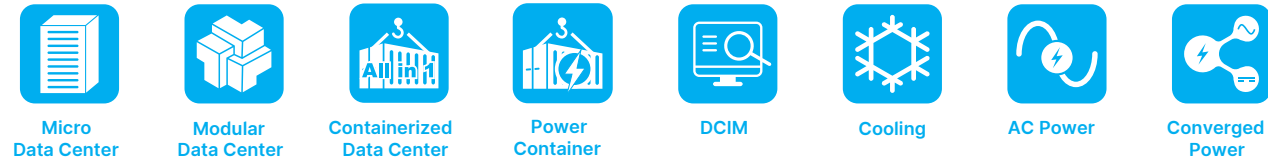

About Delta Group

Leading expert in power management and thermal management solutions

Delta, founded in 1971, is a global provider of power and thermal management solutions. Its mission statement, "To provide innovative, clean and energy-efficient solutions for a better tomorrow," focuses on addressing key environmental issues such as global climate change. As an energy-saving solutions provider with core competencies in power electronics and automation, Delta's business categories include Power Electronics, Automation, and Infrastructure.

Delta offers some of the most energy-efficient power products in the industry, including switching power supplies with efficiency over 90%, telecom power with up to 98%, and PV inverters with up to 99.2% efficiency. We have also developed the world's first server power supply certified as 80 Plus Titanium.



Global Footprint

World's No. 1 in Switching Power Supplies, DC Brushless Fans and Telecom Power Systems.

157 sales offices and **51** manufacturing facilities worldwide.

Over **8%** of annual sales revenues invested in R&D with over **10,000** engineers in **73** R&D centers worldwide.

Awarded over **12,000** patents and received internationally recognized design awards including iF, Reddot, and the Taiwan Excellence awards.

	Asia-Pacific	Americas	EMEA	Total
Sales Offices	99	29	38	166
Plant Sites	40	6	6	52
R&D Centers	48	11	14	73

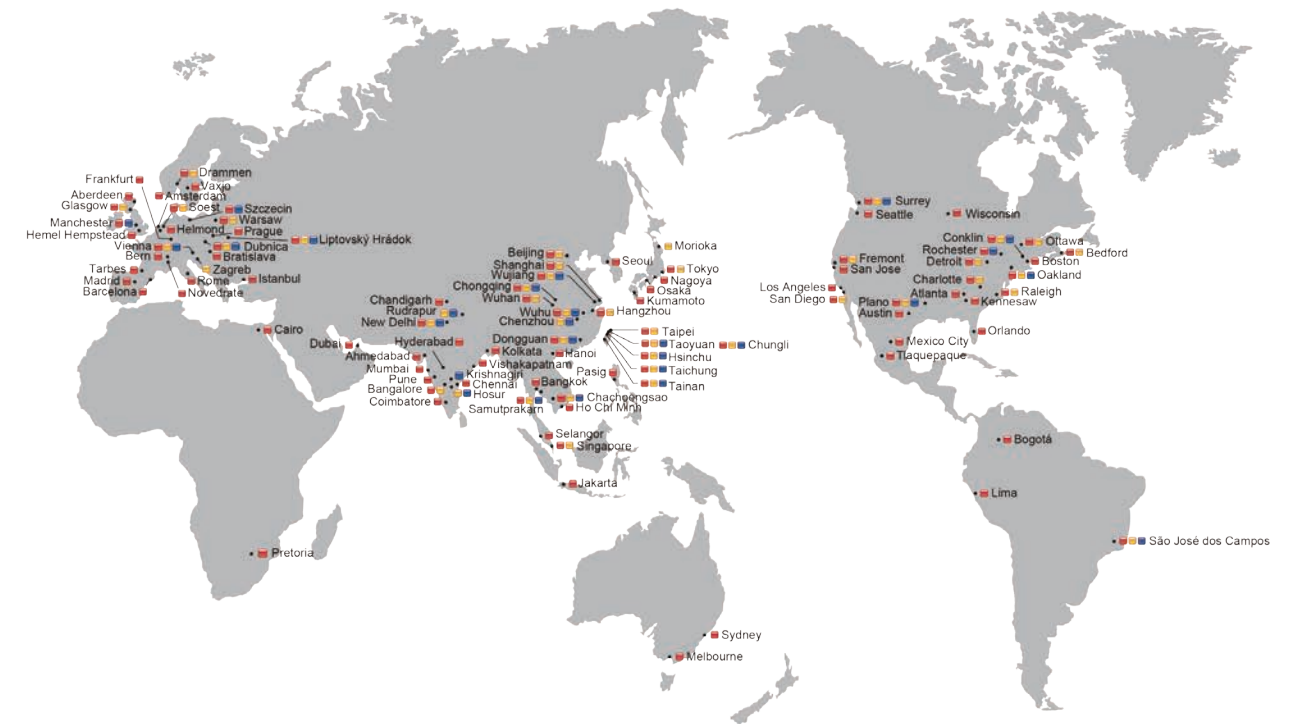

Europe

The Netherlands (EMEA Headquarters)

Delta Electronics (Netherlands) BV
T +31 (0) 20 800 39 00
E ups.netherlands@deltaww.com

Czech Republic

Delta Energy Systems
T +420 272 019 330
E ups.czech.republic@deltaww.com

Finland

Delta Solutions (Finland) Oy
T +358 9 84966 0
E ups.finland@deltaww.com

France

Delta Electronics (France) SAS
T +33 5623 40930
E ups.france@deltaww.com

Germany

Delta Electronics (Germany) GmbH
T +49 69 42002 0
E ups.germany@deltaww.com

Poland

Delta Electronics (Poland) Sp. z.o.o.
T +48 22 335 26 00
E ups.poland@deltaww.com

Slovak Republic

Delta Electronics (Slovakia) s.r.o.
T +421 2 6541 1258
E ups.slovakia@deltaww.com

Switzerland

Delta Electronics (Switzerland) AG
T +41 31 998 53 11
E ups.switzerland@deltaww.com

Spain

Delta Electronics Solutions (Spain) SLU.
T +34 91223 7420
E ups.spain@deltaww.com

Turkey

Delta Greentech Electronic San. Ltd.
T +90 216 499 9910
E ups.turkey@deltaww.com

United Kingdom

Delta Electronics (UK) Ltd.
T +44 1442 219355
E ups.united.kingdom@deltaww.com

Middle-East & Africa

South Africa

Delta Energy Systems MEA (South Africa)
T +27 12 663 2714
E ups.south.africa@deltaww.com

United Arab Emirates

Delta Electronics MEA DMCC
T +971 44 440 4966
E ups.middle.east@deltaww.com

Americas

The United States

Delta Electronics (Americas) Ltd.
T +1 510 668 5100
E ups.na@deltaww.com

Brazil

Delta Electronics Brasil Ltda.
T +55 12 3932 2300
E ups.brazil@deltaww.com

Colombia

Delta Electronics Colombia SAS
T +57 317 4052794
E ups.colombia@deltaww.com

Peru

Delta Electronics (Peru) Inc. S.R.L.
T +51 962 834 287
E ups.peru@deltaww.com

Asia Pacific

Australia

Delta Electronics (Australia) Pty Ltd.
T +61 2 9479 4200 / +61 3 9543 3720
E ups.australia@deltaww.com

China

Delta GreenTech (China) Co., Ltd.
T +86 21 5863 5678 / +86 21 5863 9595
E ups.china@deltaww.com

India

Delta Electronics India Pvt Ltd.
T +91 124 4874 900
E ups.india@deltaww.com

Indonesia

Delta Electronics International (S) Pte Ltd.
T +65 9667 4687
E ups.indonesia@deltaww.com

Japan

Delta Electronics (Japan), Inc.
T +81 3 5733 1111
E jpstps@deltaww.com

South Korea

Delta Electronics (Korea), Inc.
T +82 2 515 5303
E ups.south.korea@deltaww.com

Malaysia

E ups.malaysia@deltaww.com

Philippines

Eltek Power Inc./ Delta
E ups.philippines@deltaww.com

Singapore

Delta Electronics Int'l (Singapore)
T +65 6747 5155
E ups.singapore@deltaww.com

Taiwan

Delta Electronics Inc.
T +886 6 505 6565
E ups.taiwan@deltaww.com

Thailand

Delta Electronics (Thailand) Public Co., Ltd.
T +662 709 2800
E ups.thailand@deltaww.com

Vietnam

Delta Electronics (Vietnam) Ltd.
T +84 (0) 966 53 22 66
E ups.vietnam@deltaww.com



Delta Group



Delta Power Solutions



Delta ICT LinkedIn



Delta ICT YouTube