

Delta UPS - Amplon Family

Delta External Charger Box for
Amplon RT 1/ 2/ 3kVA UPS

Installation & Operation Quick Guide

ENGLISH



1 Product Introduction

The Delta External Charger Box works as an external charger for a 1/ 2/ 3kVA on-line UPS. Its input power factor reaches to 0.97 and efficiency is up to 90%. The charger box provides wide range of charge voltage (16Vdc to 116Vdc) for you to adjust according to battery capacity. Working with a UPS, the charger box can charge lead-acid batteries and lithium batteries. Through the provided RJ45 cable, the charger box can send alarm signals to the UPS, which enhances the UPS's monitor function.

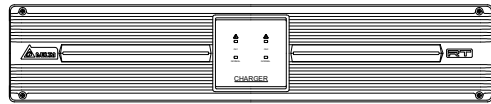

(Figure 1: Delta External Charger Box Front View)

2 Important Safety Instructions

Please read this user manual before operation and keep it for later reference. Failure to heed the manual will void the warranty.

- Install the charger box in a well-ventilated area. Do not expose it to rain, dust, and moisture. Keep it away from flammable gas or explosives.
- To protect the charger box from overheating and to ensure its reliability, do not block or cover its slits and openings.
- Do not put beverages on the charger box.
- All maintenance services must be performed by qualified personnel. Do not open or remove the cover of the charger box to avoid high voltage electric shock.
- The charger box must be well grounded due to a possible risk of current leakage.
- There is a risk of dangerous high voltage when the batteries are still connected to the charger box. Before maintenance of the charger box, do not forget to remove the input power cord and disconnect the battery cable to completely cut off the power source.
- Standard Compliance
CE and cTUVus (UL 62368-1)
FCC Class A
EN 61000-4-2, Level 4
EN 61000-4-6
EN 61000-4-3, Level 3
EN 61000-4-4, Level 4
EN 61000-4-5, 2kV (Common mode)

3 Package List

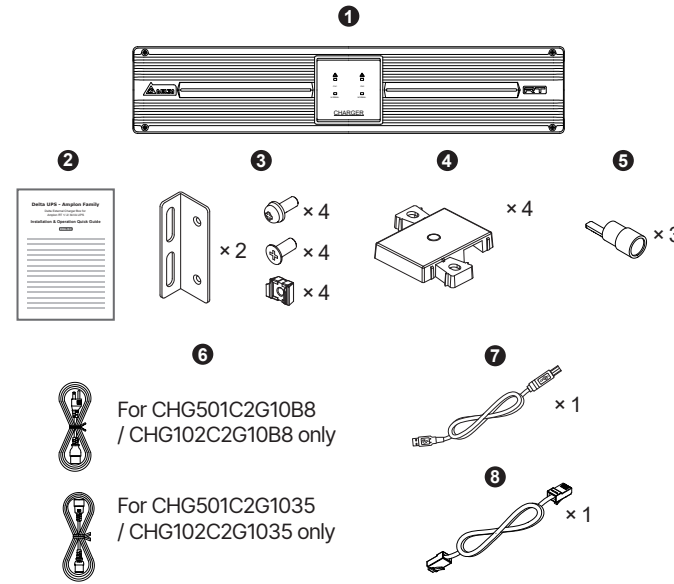

No.	Item	Q'ty
1	Delta External Charger Box	1 PC
2	Installation & Operation Quick Guide	1 PC
3	Ear kit	1 SET
4	Tower Stand Extender	4 PCS
5	Terminal CU	3 PCS
6	Input power cable	1 PC
7	Micro USB cable	1 PC
8	RJ45 Cable	1 PC

4 LED Indicators

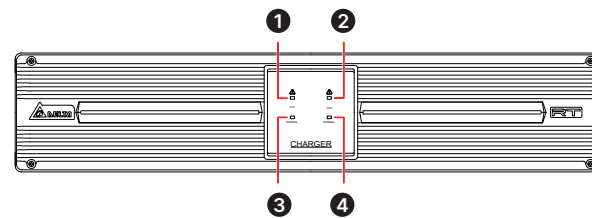

(Figure 2: LED Indicators)

LED No.	LED Status	Meaning
1	Off	CH1 works normally.
	Flashing (Red)	CH1's setting is abnormal.
	On (Red)	CH1 works abnormally.
2	Off	CH2 works normally.
	Flashing (Red)	CH2's setting is abnormal.
	On (Red)	CH2 works abnormally.
3	Off	CH1's input power is abnormal.
	Flashing (Green)	CH1's input power is out of working range.
	On (Green)	CH1's input power is normal.
4	Off	CH2's input power is abnormal.
	Flashing (Green)	CH2's input power is out of working range.
	On (Green)	CH2's input power is normal.

5 Rear Panel

- CHG501C2G1035/ CHG501C2G10B8:

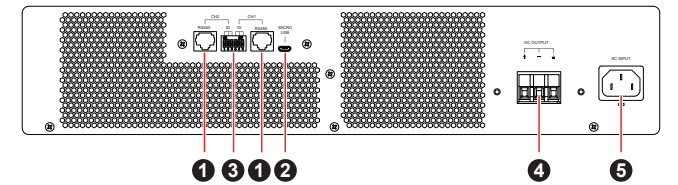

- CHG102C2G1035/ CHG102C2G10B8:

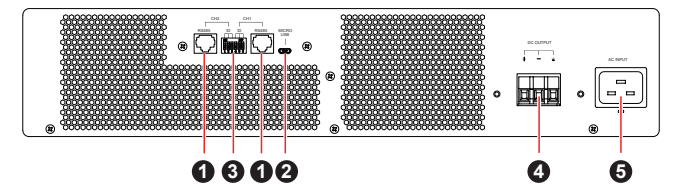

(Figure 3: Rear Panel)

No.	Printing	Meaning	Description
1	RS 485	RS 485	For connection to the RS485 port on UPS. With a UPS, you can detect charger box information and control the charging voltage to synchronize with the UPS. RS 485 and Micro-USB can not be communicated at the same time.
2	MICRO USB	Micro-USB port	For configuring the charger box's setting. NOTE: Please download the latest version of USB Driver from the following link: https://datacenter-softwarecenter.deltaww.com/Download/UPS/Software/FT230X_USB_Driver.zip
3	ID	DIP Switch	You can set communication ID by DIP Switch, please refer to Table 1 for ID setting.
4	DC OUTOUTPUT	Output Terminal	For connection to battery cabinet.
5	AC INPUT	Input Socket	For connection to power input.

Table 1 Communication ID setting

DIP Switch						FW	ID	
CH2 ID Set			CH1 ID Set				CH2	CH1
DIP1	DIP2	DIP3	DIP4	DIP5	DIP6			
OFF	OFF	OFF	OFF	OFF	OFF	0	ID11	ID11
OFF	OFF	ON	OFF	OFF	ON	0	ID12	ID12
OFF	ON	OFF	OFF	ON	OFF	0	ID13	ID13
OFF	ON	ON	OFF	ON	ON	0	ID14	ID14
ON	OFF	OFF	ON	OFF	OFF	0	ID15	ID15
ON	OFF	ON	ON	OFF	ON	0	ID16	ID16
ON	ON	OFF	ON	ON	OFF	0	ID17	ID17
ON	ON	ON	ON	ON	ON	0	ID18	ID18
OFF	OFF	OFF	OFF	OFF	OFF	1	ID19	ID19
OFF	OFF	ON	OFF	OFF	ON	1	ID20	ID20
OFF	ON	OFF	OFF	ON	OFF	1	ID21	ID21
OFF	ON	ON	OFF	ON	ON	1	ID22	ID22

DIP Switch						FW	ID	
CH2 ID Set			CH1 ID Set				CH2	CH1
DIP1	DIP2	DIP3	DIP4	DIP5	DIP6			
ON	OFF	OFF	ON	OFF	OFF	1	ID23	ID23
ON	OFF	ON	ON	OFF	ON	1	ID24	ID24
ON	ON	OFF	ON	ON	OFF	1	ID25	ID25
ON	ON	ON	ON	ON	ON	1	ID26	ID26



NOTE:

1. Please set different ID of CH1 and CH2.
2. Please restart the charger box after FW ID is set, otherwise, FW ID setting is ineffective.

6 Installation and Configuration

6.1 Installation

• Rack Mounting:

- 1 Attach the included bracket ears to the lateral mounting holes of the Delta external charger box. See **Figure 4**.

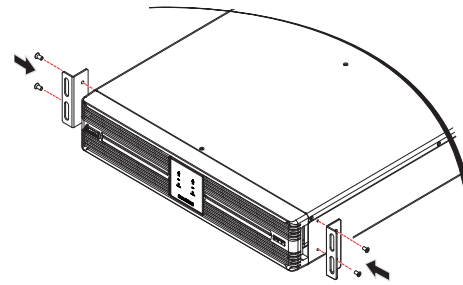

(Figure 4: Mount the Bracket Ears)

- 2 Follow steps 1 to 2 to install the Delta External Charger Box in Delta's rail kit (optional). See **Figure 5**.

Step 1: Adjust the length of the rails according to your rack.

Step 2: Tighten the rails' nuts.

Step 3: Fix the rails on your rack.

Step 4: Install the Delta external charger box on your rack and tighten the provided screws.

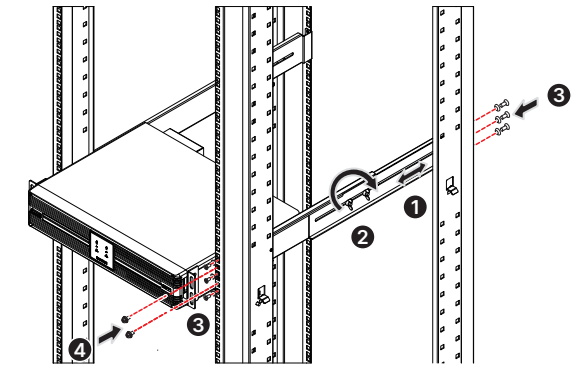

(Figure 5: Install the Delta External Charger Box on Your Rack)



NOTE:

4. If you want to use a non-Delta rail kit, please only follow step 4.

• Tower Mounting:

- 1 Connect the provided tower stand extenders with the tower stands provided in the UPS's carton (please take the UPS and the Delta external charger box's size into consideration). See **Figure 6**.

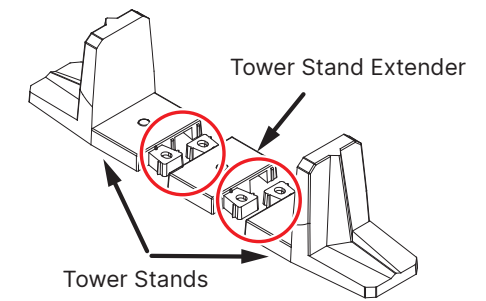

(Figure 6: Connect the Tower Stand Extenders with the UPS's Tower Stands)

- 2 Pull out the Delta external charger box's control panel (1 & 2), rotate it 90° clockwise (3) and re-insert the control panel (4). After that, rotate the Delta logo nameplate 90° clockwise (5). See **Figure 7**.

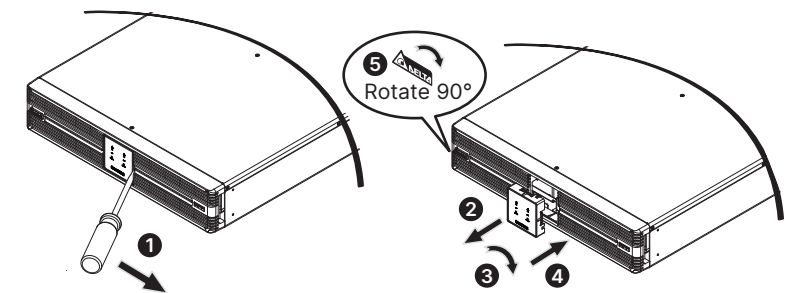

(Figure 7: Rotate the Delta External Charger Box's Control Panel & Delta Logo Nameplate)

- 3 Carefully lift the Delta external charger box upright with the Delta logo  and the icon shown on the control panel facing up. A minimum of two people are required. See **Figure 8**.

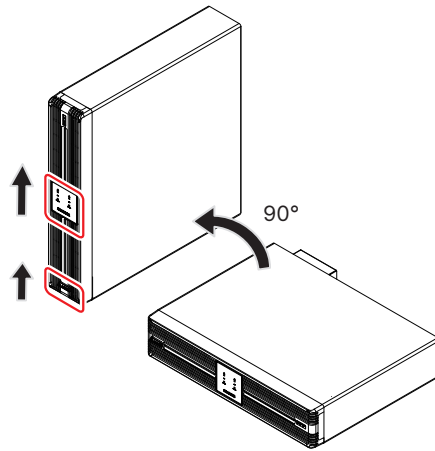

(Figure 8: Place the Delta External Charger Box Upright)

- 4 Place the Delta external charger box and the UPS inside the tower stands. See **Figure 9**.

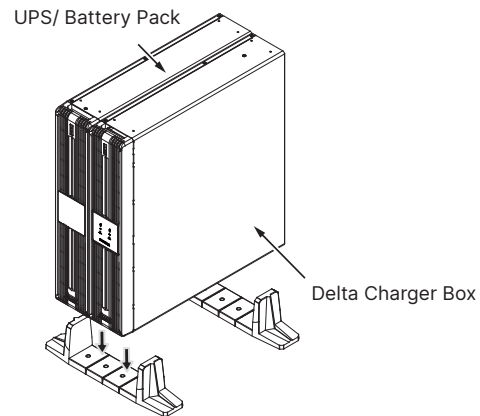

(Figure 9: Place the Delta External Charger Box and the UPS inside the Tower Stands)

- Connect the Delta external charger box to UPS

- 1 Use the input power cord provided in package to connect the external charger box to line power.
- 2 When connecting the external charger box to the mains, it is highly recommended that you install the protective devices. Please refer to the table below.

External Charger Box Model	Suggested Protective Device
CHG96V-RT-1	250 Vac/ 10A breaker
CHG96V-RT-2	250 Vac/ 16A breaker

- 3 Select proper output cables and cable gland, and compress the terminal CU in package to one end of the cable. Connect the terminal end to charger box's output terminal block and the other end to external battery pack. See **Figure 10**.

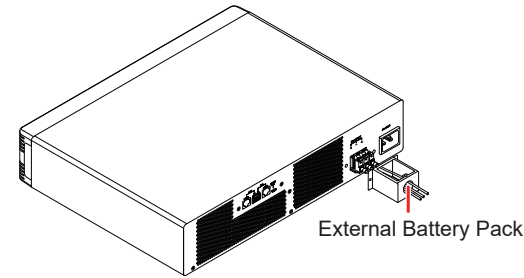

(Figure 10: Install Output Cables)

- 4 For the specification of input/ output cables, please refer to below table.

Spec. / Capacity	CHG96V-RT-1/ CHG96V-RT-2
Input/ Output Cables (Rating Temperature 90°C)	#12 AWG (3 mm ²)
Tightening Torque	5.07 kgf-cm (4.40 lb-in)

6.2 Configuration

6.2.1 Configure the charger box automatically

When the charger box is communicated with UPS (UPS need support charger box's communication protocol) through RS485, charger box's configuration is controlled by UPS, that is, follows UPS's setting. Please refer to **Figure 11** and **Figure 12** for connection.

- Connect single charger box to UPS

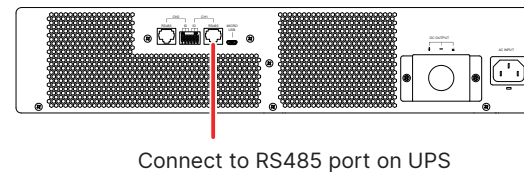

(Figure 11: Connect Single Charger Box to UPS)

- Connect paralleled charger boxes to UPS

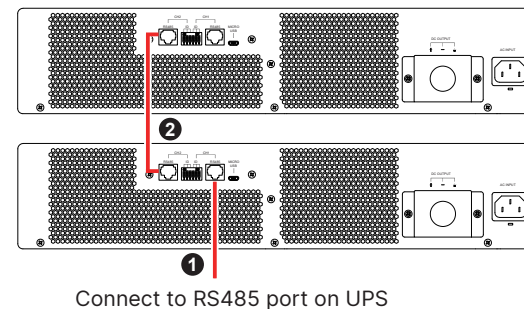

(Figure 12: Connect Paralleled Charger Boxes to UPS)

7 Troubleshooting

LED Indicators	Problems	Solutions
LED flashes (Red)	The charger box's setting is abnormal.	Check whether the configuration is correct. If all configuration is correct, please contact your local dealer or customer service representative.
LED on (Red)	The charger works abnormally.	Check whether the input power is abnormal. 2. The charger board's power is abnormal. 3. The charger board is not well connected.
LED off (Green)	The input power is out of working range.	Check whether the input cables are firmly connected. If not, connect them. If the input cables are firmly connected but the LED still flashes or off, please contact your local dealer or customer service representative.

8 Maintenance

Charger Box Cleaning:

- Regularly clean the charger box, especially the slits and openings, to make sure air flows freely through the charger box to avoid overheating.

Charger Box Inspection:

- Regularly check the charger box and inspect:
 - Whether the LED indicators are normal.
 - Whether the fan works normally and air flows freely through the charger box.

Fan:

- Higher temperatures shorten fan life. When the charger box is running, please check if the fan works normally and make sure the charger box is ventilated properly. If not, replace the fan.



NOTE:

Please ask your local dealer or customer service representative for more maintenance information. Do not perform maintenance if you are not trained for it.

9 Technical Specifications

Delta External Charger Box		CHG96V-RT-1	CHG96V-RT-2
Input	Voltage Range	100~280Vac (Full load)	
	Frequency	40~70Hz	
	Current Rate	7A	14A
	Power Factor	> 0.97	
	Protective Device	15A fuse (charger board)	
Output	OutputPower	500W	1000W
	Charging Voltage	16 ~ 116 Vdc	16 ~ 116 Vdc
	Charging Current (Maximum)	8A	16A
Dimensions (W × D × H)		440 × 395 × 88.5 mm (17.3" × 15.6" × 3.5")	
Weight		5.3 kg (11.7 lb)	6.8 kg (15.0 lb)
Noise		< 45dBA@ < 30°C amb * ¹	
Environment	Operating Temperature	0 ~ 55°C (32 ~ 104°F) * ²	
	Relative Humidity	0 ~ 95% (non-condensing)	



NOTE:

- *¹ At a distance of 3.28 ft (1 meter) in front of the Delta external charger box.
- *² De-rate to 75% load when the operating temperature is between 41°C~50°C (106°F~122°F), de-rate to 50% load when the operating temperature is between 51°C~55°C (124°F~131°F).
- Refer to the rating label for the safety rating.
- All specifications are subject to change without prior notification.

- Global Headquarter

Taiwan

Delta Electronics Inc.
39 Section 2, Huandong Road, Shanhua District,
Tainan City 74144, Taiwan
T +886 6 505 6565
E ups.taiwan@deltaww.com

- Regional Office

The United States

Delta Electronics (Americas) Ltd.
46101 Fremont Blvd. Fremont, CA 94538
T +1 510 344 2157
E ups.na@deltaww.com

South America

Delta Electronics Brasil Ltda.
Estrada Velha Rio-São Paulo, 5300 – Eugênio de Melo – CEP 12247-001
São José dos Campos-SP-Brasil
T +55 12 39322300
E ups.brazil@deltaww.com

China

Delta GreenTech (China) Co., Ltd.
238 Minxia Road, Pudong, Shanghai, 201209 P.R.C
T +86 21 5863 5678
+86 21 5863 9595
E ups.china@deltaww.com

Singapore

Delta Electronics Int'l (Singapore) Pte Ltd.
4 Kaki Bukit Ave 1, #05-04, Singapore 417939
T +65 6747 5155
E ups.singapore@deltaww.com

EMEA

Delta Electronics (Netherlands) BV
Zandsteen 15, 2132MZ Hoofddorp, The Netherlands
T +31 20 655 09 00
E ups.netherlands@deltaww.com

Australia

Delta Energy Systems Australia Pty Ltd.
Unit 20-21, 45 Normanby Road, Notting Hill VIC 3168, Australia
T +61 3 9543 3720
E ups.australia@deltaww.com

Thailand

Delta Electronics (Thailand) Public Co.,Ltd.
909 Soi 9, Moo 4, E.P.Z., Bangpoo Industrial Estate, Tambon Prakasa,
Amphur Muang-samutprakarn, Samutprakarn Province 10280, Thailand
T +662 709-2800
E ups.thailand@deltaww.com

South Korea

Delta Electronics (Korea), Inc.
1511, Byucksan Digital Valley 6-cha, Gasan-dong, Geumcheon-gu,
Seoul, Korea, 153-704
T +82-2-515-5303
E ups.south.korea@deltaww.com

India

Delta Power Solutions (India) Pvt. Ltd.
Plot No. 43, Sector-35, HSIIIDC, Gurgaon-122001, Haryana, India
T +91 124 4874 900
E ups.india@deltaww.com

Japan

Delta Electronics (Japan), Inc.
2-1-14 Shibadaimon, Minato-Ku, Tokyo, 105-0012, Japan
T +81-3-5733-1111
E jpstps@deltaww.com

UK

Delta Electronics (UK) Ltd.
Eltek House Cleveland Road, Hemel Hempstead Industrial Estate,
Hemel Hempstead, Hertfordshire, HP2 7EY
T +44 1442 219355
E sales.gb@eltek.com

Copyright © 2022 by Delta Electronics Inc.
All rights reserved. Changes may be made
periodically to the information in this Quick Guide
without obligation to notify any person of such
revision or changes.

No. 501330220101
Version : V 1.1
Release Date : 2022_08_23